

PROTECT YOUR CHILDREN

Be aware that it is possible for children to strangle in window covering cords. To reduce the occurrence of accident, all cords must be kept out of the reach of children, including infants. Cord cleats are an effective way to implement this essential precaution.

Mount the cord cleat at a safe height, taking into account furniture or other objects upon which a child may climb. Then, after each use of the shade, simply wrap the excess cord around the cleat. It's fast, easy and safe.

To protect your children, we are pleased to provide cord cleats free of charge with every shade that we manufacture.



CLEANING AND CARE

The shade fabric is easy to care for. Regular dusting with a feather duster or vacuum cleaner brush is recommended. Most stains can be blotted with a damp sponge and mild detergent. For problem stains, the shade can be removed from the installation brackets and soaked in warm water. When damp, raise shade tightly to re-crisp pleats. Before using anything stronger than mild detergent and lukewarm water, test an unobtrusive corner of the shade. If you have any questions, call your dealer for advice.

KENSINGTON

WINDOW EXPRESSIONS™

PLEATED TOP-DOWN/BOTTOM-UP RECTANGULAR SHADES

INSTALLATION & OPERATING INSTRUCTIONS

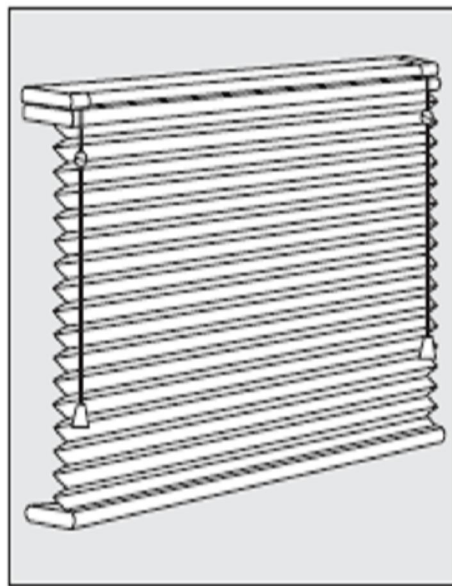

BASICS

A few simple tools are required:

- Measuring tape
- Power drill, drill bits
- Hex head and/or Phillips driver bit
- Pencil

Additional fasteners other than those sent with your shade may be required depending on the mounting surface. Wallboard and plaster require the use of anchors such as expansion or toggle bolts. Brick, tile or stone need special plugs and drill bits. Remember to always pre-drill holes in wood to avoid splitting.

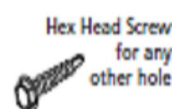
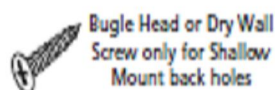

Hold Down Bracket (Optional)



Extension Bracket (Optional)

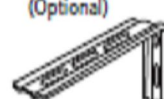

Our Top-Down/Bottom-Up shades are constructed to be hung as either an inside mount or an outside mount. The installation bracket can be mounted inside the window opening, for an inside mount, or on the molding or wall above the window for an outside mount. The extension bracket and the hold down bracket are optional items requested at the time of ordering the shade. The extension bracket provides projection of the installation bracket in order to clear obstructions. The hold down bracket keeps the shade from swaying and is often used for installation on door windows.

Shallow Mount back hole



Shallow Mount back hole

BRACKET INSTALLATION

Shades are shipped with the required number of brackets for proper installation. End brackets should be located with centerlines 2 1/2" in from each end. Depending on the width of the shade, additional brackets may be necessary evenly spaced between the two end brackets.

For shade widths of:	Use this number of brackets:
Up to 40"	2
40" to 72"	3
72" to 84"	4
84" and up	5

Using the installation bracket as a template, measure and mark the center lines. When mounting brackets, make sure they are in line and level.

On shades 84" to 96" wide it is recommended to use a second bracket located next to the end bracket at the Cord Lock.

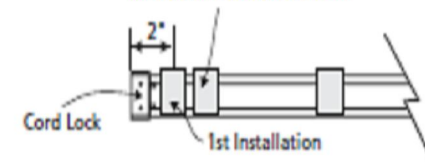

INSIDE MOUNT

The brackets are mounted flat against the top sill surface. Place the bugle head screw through the hole closest to the front of the bracket. To fully recess the shade requires a flat surface with a minimum depth of 1 3/4". Shallow mounting requires 1/2" minimum.

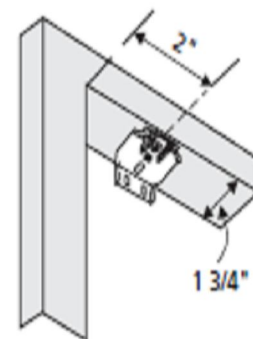

HOW TO OPERATE YOUR SHADE

On a standard Top-Down/Bottom-Up shade, the right hand cord operates the middle rail, while the left hand cord operates the bottom rail.

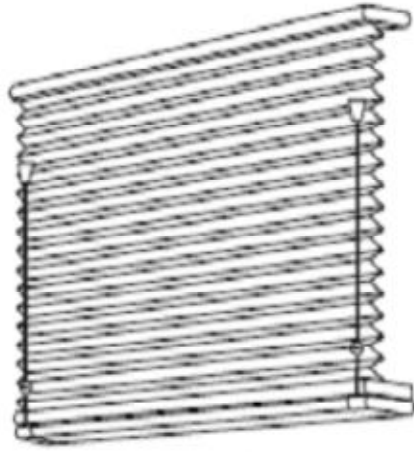

CORDLOCK OPERATION

To raise or lock either the middle rail or bottom rail of the shade, pull the cord down and inward to the center of the shade.

NOTE: When raising the middle rail all of the way to the head rail, you should raise the bottom rail a couple of inches. This will prevent pinching the equalizer between the rails.

To lower or lock either the middle rail or bottom rail of the shade, pull the cord directly downward in the vertical position to release the lock.

Pull cord down, raising Bottom Rail to lower Equalizer so it will not get caught between the Head Rail and the Middle Rail. Do this prior to raising the Middle Rail.

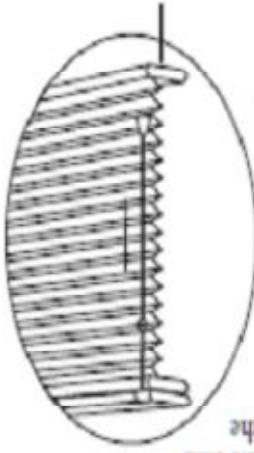

OPTIONAL HOLD DOWN BRACKET

Optional Hold Down Brackets are mounted with the supplied screws. With the shade at its proper drop, place the pin of each Hold Down into the hole in each End Cap and mark the screw holes. Make sure the pins are level and aligned. Raise the shade, then screw the Hold Down Bracket into the mounting surface.



TWO-ON-ONE HEADRAIL SPICER

For shades ordered as Two-on-One Headrail using the Spicer piece, insert Spicer in Headrail of both shades as shown. Lock into place using 3/8" Tek screws provided.

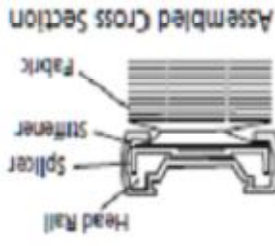
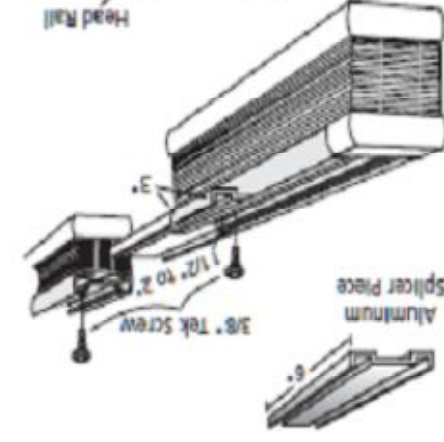

Assembled Cross Section

OUTSIDE MOUNT

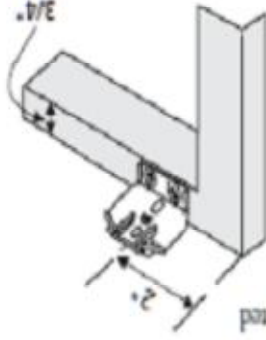

The brackets are mounted with two bugle head screws through the back end of the bracket flat against the window making or the wall above the window. The bracket requires a minimum surface 3/4" high.

SIDE MOUNT

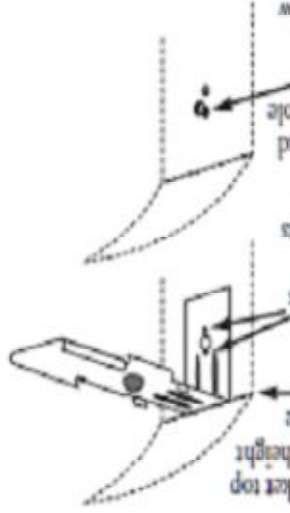

1. Line up the bracket top with the desired height of the top of the headrail.
2. Mark holes for screws. Brackets must be level. Remove brackets and drill holes.
3. Insert bugle head screws for keyhole slots only. Approximately 1/8" of the screw should be left protruding.



4. Pull the cord lock assembly partially out of the headrail and slide the bracket on as shown. Push the cord lock as assembly and bracket back all the way into the rail.

5. Remove the endcap from the opposite end of the headrail. Slide the remaining side mount bracket on the headrail. Replace the end cap before sliding the bracket all the way into the headrail.

OPTIONAL EXTENSION BRACKETS

6. Hook one bracket onto the screw in the window frame, using the keyhole slot. Bring the other end and bracket over the screw at the other side of the frame. Slide down, flexing bracket inward until the screw engages in the keyhole slot.
7. Make sure both brackets are slipped down all the way in the keyhole slot so that the screw is in the top portion of the keyhole slot. Install a screw in the bottom hole of each bracket. Tighten all screws.

Optional extension brackets are used to project the back of the shade up to 2 3/8" from the mounting surface. Attach the installation bracket to the extension bracket with the nut and bolt provided.

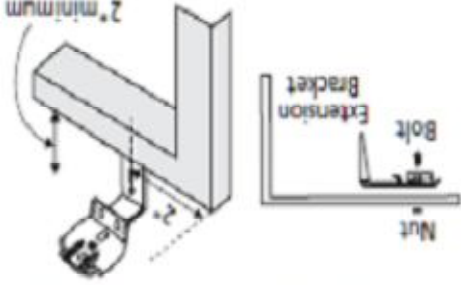

HANGING THE SHADE

Lower the cord from the shade but keep the rubber band around the shade stack.

1. Hold the shade up near the brackets and insert the front clip of the bracket into the front groove of the rail.
2. Make sure the shade is centered in the window opening.
3. Push the rail back and up until the back clips of the bracket are inserted in the back groove of the rail.

To remove the shade, reverse the procedure.

